



VICEVERSA

NOE' DUCHAUFOR LAWRENCE / 2019

EN: Suspension lamp. Suspension lamp. Diffuser made of mouth blown glass. Metallic structure.

IT: Lampada a sospensione. Diffusore in vetro soffiato. Struttura in metallo verniciato.

CERTIFICATIONS / CERTIFICAZIONI

 Product in class I
Apparecchio di classe I

IP20 Product for indoor use*
Apparecchio per uso interno*

 Product in conformity with the European directive 2006/95/EC
Apparecchio conforme alla direttiva europea 2006/95/EC

 This lamp must be disposed in conformity with the EU directive 2002/96/EC
Apparecchio di illuminazione da smaltire secondo la direttiva EU 2002/96/EC

*Canopy IP20 - structure built in compliance with IP54 specifications
*Rosone IP20 - struttura costruita in conformità alle specifiche IP54

CODES AND DIMENSIONS / CODICI E DIMENSIONI

VICEVERSA

K370280GA
K370280GF

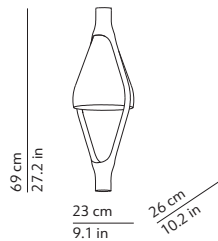

VICEVERSA 2

K370281GA
K370281GF

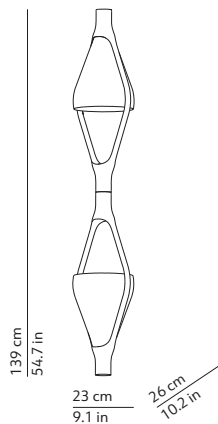

PACKAGING / IMBALLO

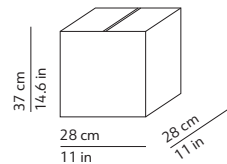

Diffuser
Volume: 0.029 m³ / 1.024 ft³
Gross weight: 2.20 kg / 4.84 lbs

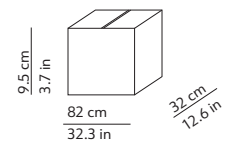

Structure x2
Volume: 0.025 m³ / 0.880 ft³
Gross weight: 4.00 kg / 8.80 lbs

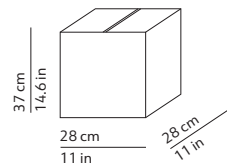

Diffuser x2
Volume: 0.029 m³ / 1.024 ft³
Gross weight: 2.20 kg / 4.84 lbs

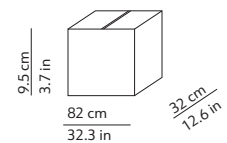

Structure x2
Volume: 0.025 m³ / 0.880 ft³
Gross weight (Viceversa): 4.00 kg / 8.80 lbs
Gross weight (Viceversa 2): 3.13 kg / 6.89 lbs

MATERIALS AND FINISHINGS / MATERIALI E FINITURE

DIFFUSER / DIFFUSORE

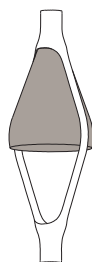

 Amber / Ambra

 Smokey grey / Fumè

Mouth blown glass
Vetro soffiato

STRUCTURE / STRUTTURA



 Grey / Grigio
RAL7016

Metallic structure
Struttura in metallo verniciato.

VICEVERSA



230V or 120V Feeding / Alimentazione

Bulbs / Lampadine
1 x 6,5W - 2700 K - 800 lm - CRI>90 - Board led

 Energy efficiency class A+

 Dimmable / Dimmerabile
1-10V or PUSH

 Suspension lamp
Lampada a sospensione

 Canopy - diam. 7.9in h. 1.6in - colour grey RAL 7016+
 canopy - diam. 2.4in h. 0.6in - colour grey RAL 7016
fixed to the ceiling with not provided screws (2-4)+
Rosone - diam.20cm h. 4cm - colore grigio RAL 7016+
rosone - diam.6cm h. 1.5cm - colore grigio RAL 7016
fissato a soffitto con tasselli (2-4) non forniti

 Black cord set - length ca. 70.9 in
different lengths on request
Cavo di alimentazione nero - lunghezza ca. 180cm
altre lunghezze su richiesta

VICEVERSA 2



230V or 120V Feeding / Alimentazione

Bulbs / Lampadine
2 x 6,5W - 2700 K - 1600 lm - CRI>90 - Board led

 Energy efficiency class A+

 Dimmable / Dimmerabile
1-10V or PUSH

 Suspension lamp
Lampada a sospensione

 Canopy - diam. 7.9in h. 1.6in - colour grey RAL 7016+
 canopy - diam. 2.4in h. 0.6in - colour grey RAL 7016
fixed to the ceiling with not provided screws (2-4)+
Rosone - diam.20cm h. 4cm - colore grigio RAL 7016+
rosone - diam.6cm h. 1.5cm - colore grigio RAL 7016
fissato a soffitto con tasselli (2-4) non forniti

 Black cord set - length ca. 70.9 in
different lengths on request
Cavo di alimentazione nero - lunghezza ca. 180cm
altre lunghezze su richiesta

POSSIBILITA' DI INSTALLAZIONE / INSTALLATION OPTIONS

ROSONE / CANOPY

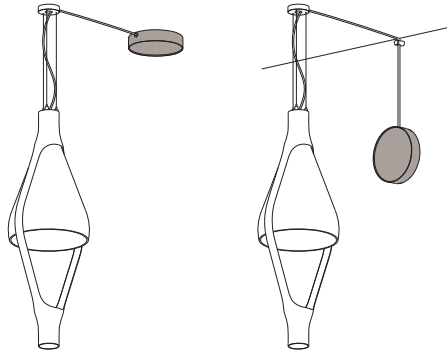

DIFFUSORE E STRUTTURA / DIFFUSER AND STRUCTURE

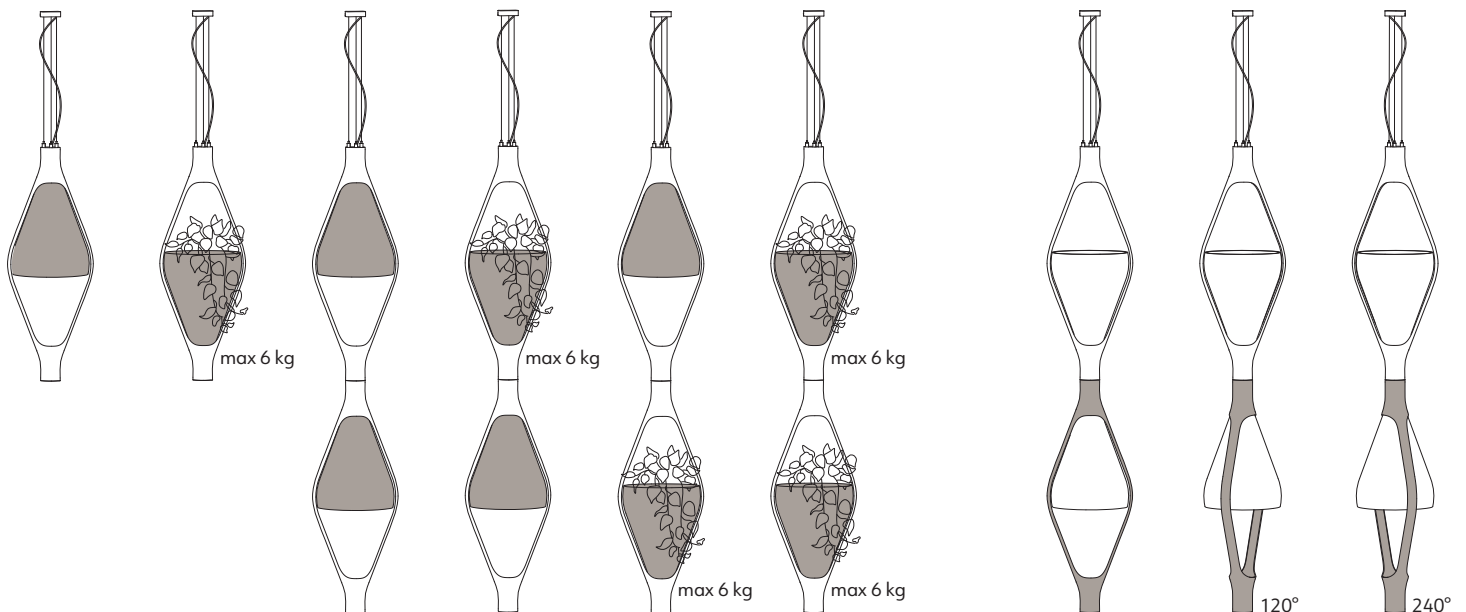

kdlⁿ

kundalini.it

ASSEMBLY INSTRUCTIONS
ISTRUZIONI DI MONTAGGIO
INSTRUCCIONES DE MONTAJE
MONTAGE-ANLEITUNG
INSTRUCCIONES DE MONTAJE

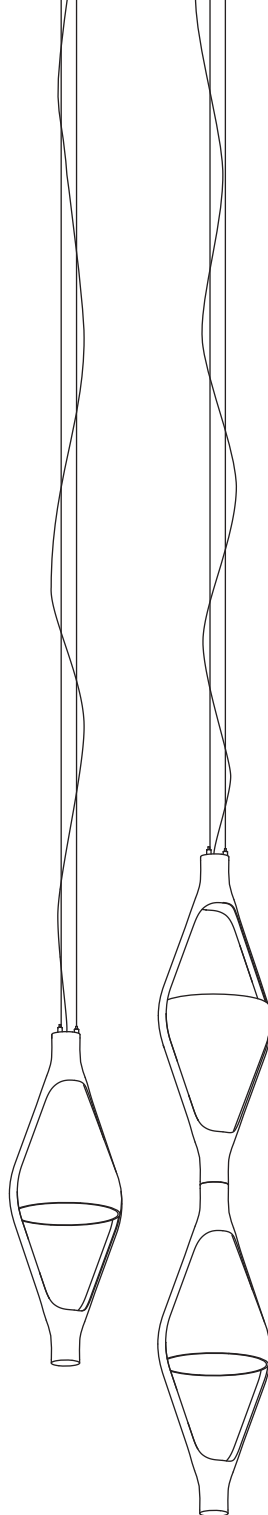

VICEVERSA

NOÉ DUCHAUFOUR LAWRENCE / 2019



Class I / Classe I / Classe I / Schutzklasse I / Clase I

- EN. Appliance suitable for installation on normally inflammable surfaces.
- IT. Apparecchio idoneo ad essere installato su superfici normalmente in infiammabili.
- FR. Appareil destiné à être installé des surfaces normalement inflammables.
- D. Gerät, welches auf Oberflächen installiert werden kann, die normalerweise entzündbar sind.
- ES. Aparato apto para ser instalado sobre superficies normalmente inflamables.



- EN. It certifies the conformity of the product to the european community low voltage directive.
- IT. Attesta la conformità del prodotto alle disposizioni delle direttive comunitarie.
- FR. Il atteste la conformité du produit aux dispositions des directives communautaires.
- D. Das Zeichen bestätigt die Übereinstimmung des Produkts mit den Bestimmungen der EU-Richtlinien.
- ES. Certifica la conformidad del producto a las disposiciones de las normas de la comunidad.



- EN. The use of the WEEE symbol indicates that this product may not be treated as household waste.
- IT. Il simbolo RAEE utilizzato per questo prodotto indica che quest'ultimo non può essere trattato come rifiuto domestico.
- FR. L'utilisation du symbole WEEE indique que ce produit ne peut pas être traité comme déchet domestique.
- D. Durch Verwendung des WEEE-Symbols weisen wir darauf hin, dass dieses Produkt nicht als normaler Haushaltsmüll behandelt werden darf.
- ES. El símbolo RAEE en un producto indica que éste no se puede eliminar como cualquier otra basura.



WARNING

The safety is guaranteed by the appropriate use of the following instructions, so you must keep them. Always disconnect the main voltage before working on the appliance. Never use abrasive products or aggressive detergents for cleaning the lamp. If the external cable of this appliance is damaged, it must be replaced by the manufacturer, its after sales service or other equivalent qualified person only in order to avoid any danger. Kundalini will not provide a replacement until the nature of defect has been determined.

ATTENZIONE

La sicurezza dell'apparecchio è garantita con l'uso appropriato delle seguenti istruzioni, pertanto è necessario conservarle. Togliere sempre la tensione prima di operare sull'apparecchio. Per pulire la lampada non usare mai prodotti abrasivi o detersivi aggressivi. Se il cavo esterno di questo apparecchio viene danneggiato, deve essere sostituito esclusivamente dal costruttore, dal suo servizio assistenza, o da personale qualificato equivalente, al fine di evitare pericoli. Kundalini non effettuerà nessuna sostituzione se non dopo aver accertato la natura del difetto.

ATTENTION

La sûreté de l'appareil n'est garantie qu'en suivant scrupuleusement les instructions ci-après. Il est donc nécessaire de les conserver. Isoler l'appareil du secteur avant toute manipulation. Pour nettoyer la lampe, ne jamais utiliser de produits abrasifs ou de nettoyeurs agressifs. Si le câble externe de cet appareil est endommagé, il doit être remplacé uniquement par les soins du constructeur, par son service après-vente ou bien par le personnel équivalent, et ce afin d'éviter tout danger. Kundalini ne remplacera aucun appareil sans en avoir pu vérifier le défaut.

ACHTUNG

Die Sicherheit dieses Artikels wird nur durch die strikte Befolgung der nachfolgenden Betriebsanleitung gewährleistet. Bitte heben Sie diese unbedingt auf. Vor allen Arbeiten ziehen Sie bitte den Stecker aus der Dose. Für die Reinigung der Lampe niemals Schleifmittel oder aggressive Reinigungsmittel verwenden. Sollte das Außenkabel der Lampe beschädigt werden, ist es ausschließlich vom Service-Dienst des Herstellers oder gleichwertigen, qualifiziertem Personal auszutauschen, um somit Gefahren zu vermeiden. Kundalini leistet grundsätzlich erst nach einer gründlichen Überprüfung Ersatz.

ATENCIÓN

La seguridad del aparato está garantizada sólo con el uso apropiado de las instrucciones siguientes, por lo tanto es necesario atenderlas puntualmente. Desconectar siempre la alimentación antes de trabajar en el aparato. Nunca utilice productos abrasivos o detergents agresivos para limpiar la lámpara. Si el cable externo de este aparato se deteriora será necesario sustituirlo; la sustitución podrá efectuarla exclusivamente el fabricante, su servicio de asistencia o personal cualificado equivalente para evitar peligros. Kundalini no efectuará sustitución alguna hasta después de haber verificado la naturaleza del defecto.

Viceversa

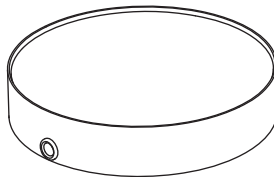
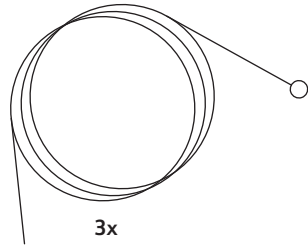
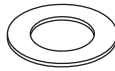
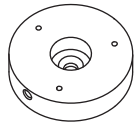
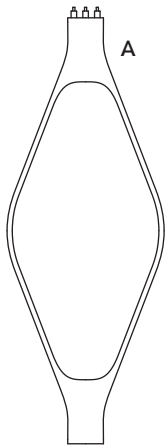

BOX N.1 - A

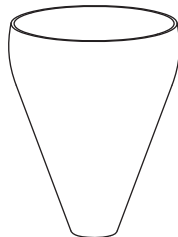

BOX N.2

Viceversa 2

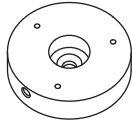
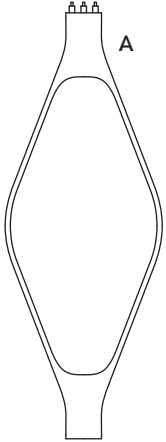

2x

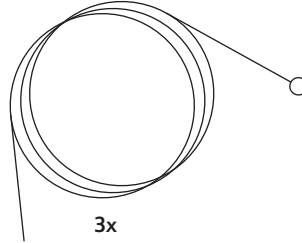
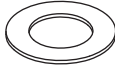
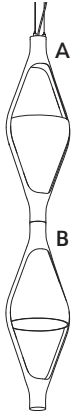

3x

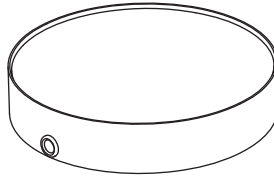

BOX N.1 - A

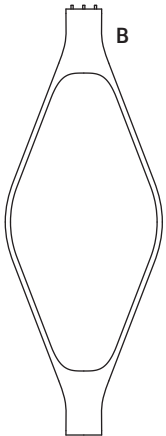

3x

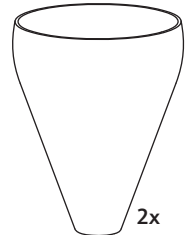

2x

BOX N.2 - B

BOX N.3 - 4

Viceversa

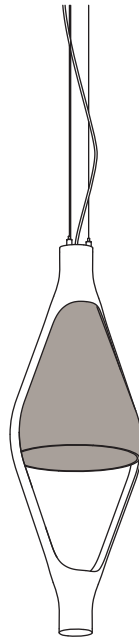
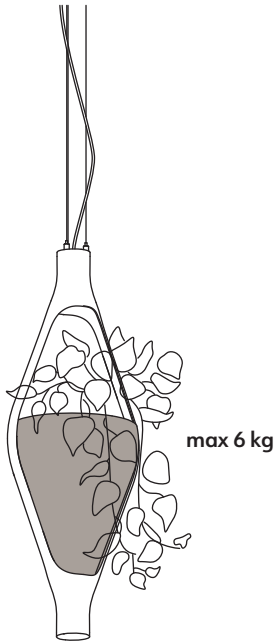

max 20 kg

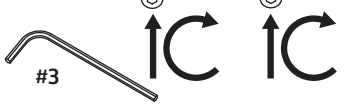
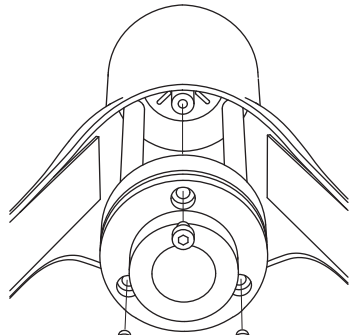
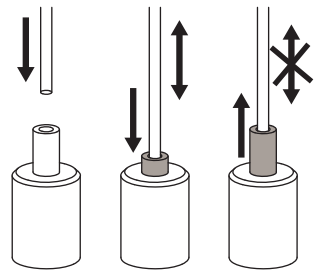
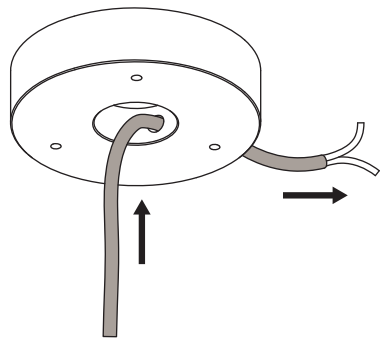
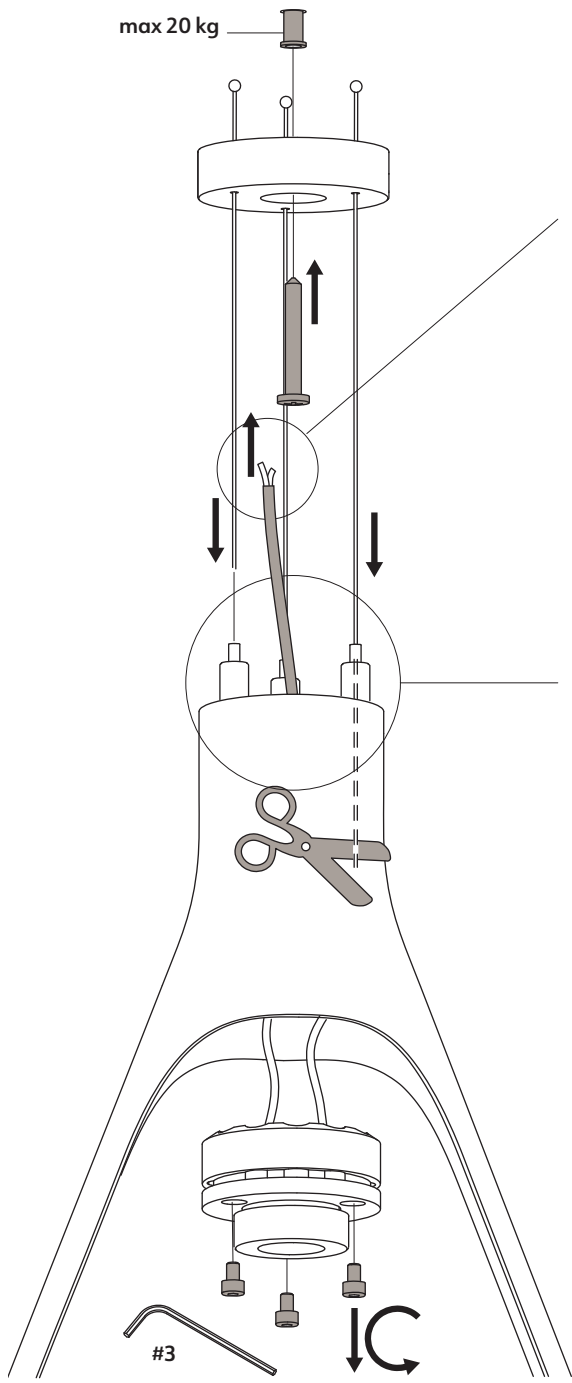

.1

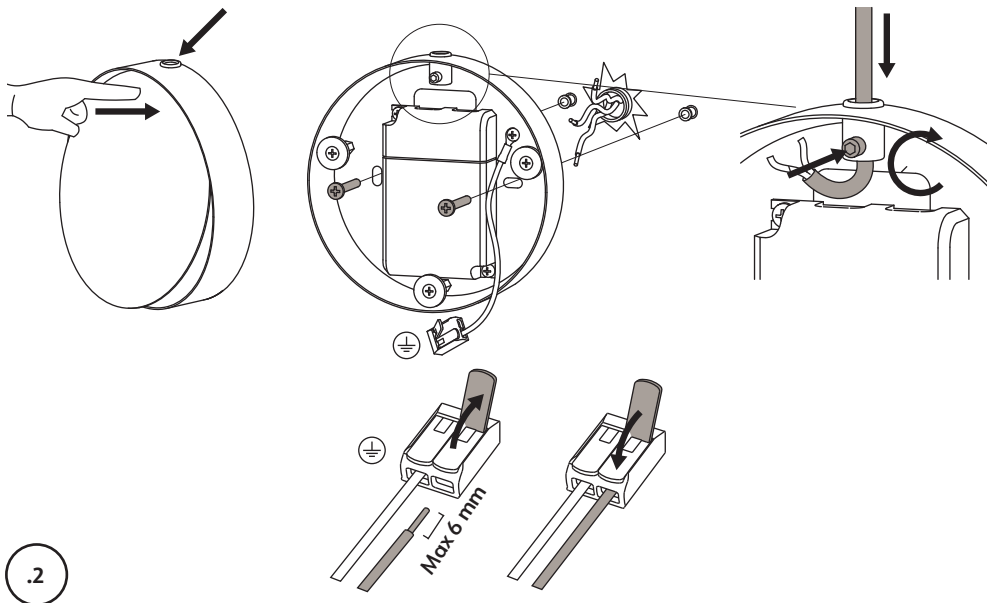

.2

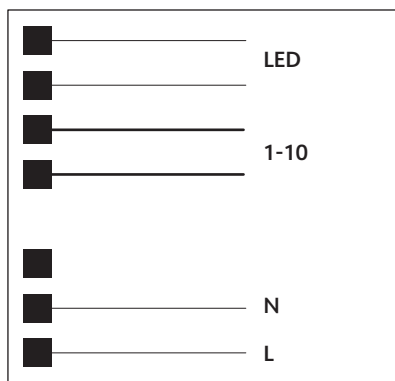
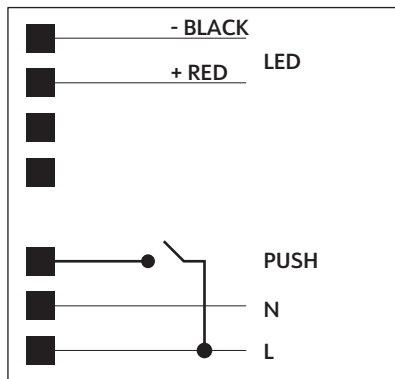
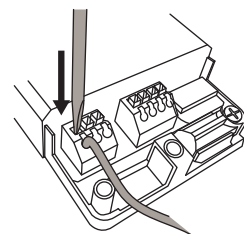
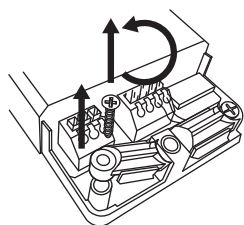
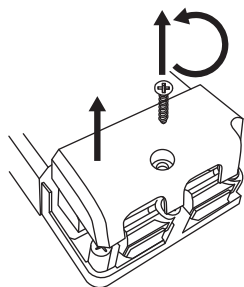

.3

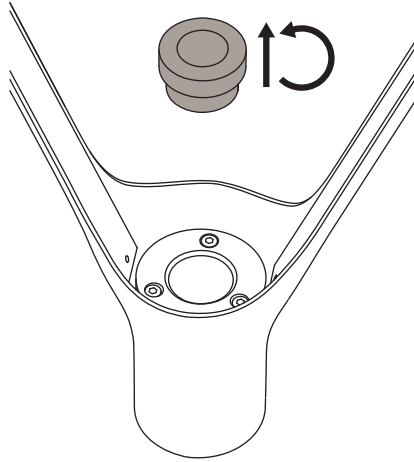

.4

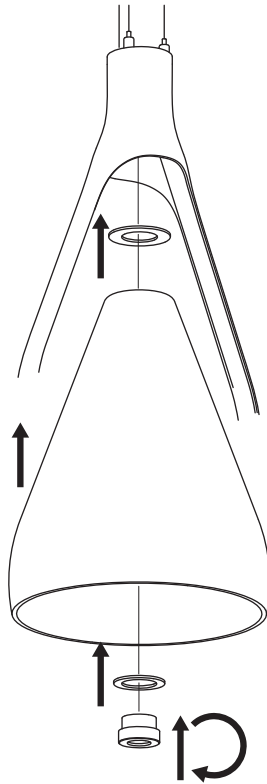
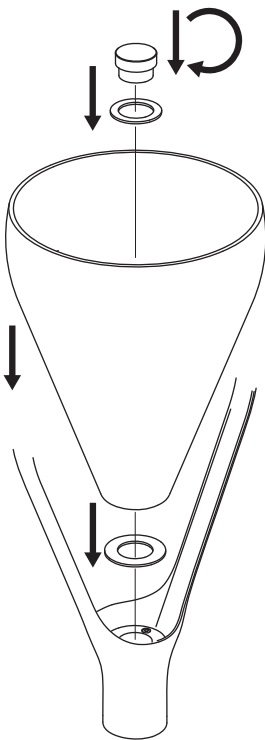

.5

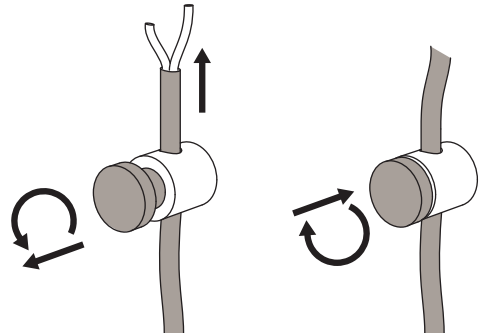
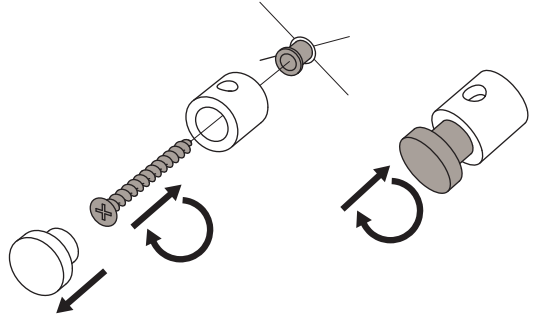
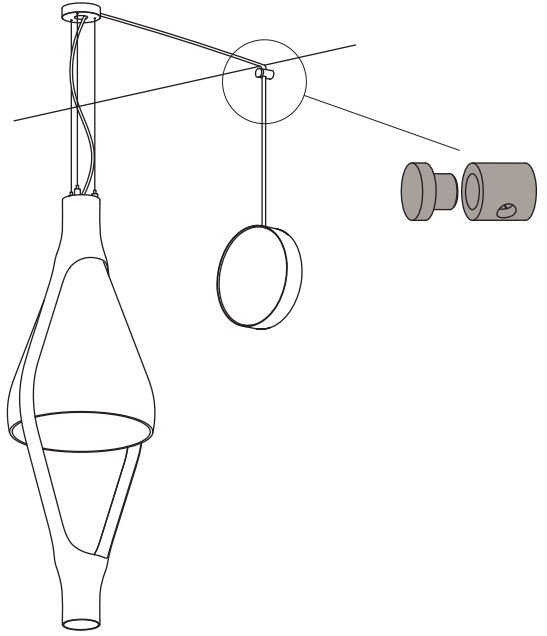
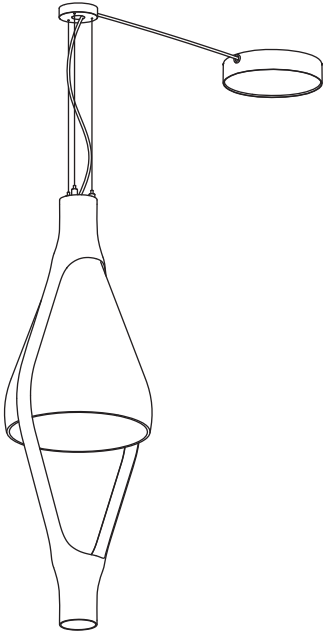

Viceversa 2



120°



240°

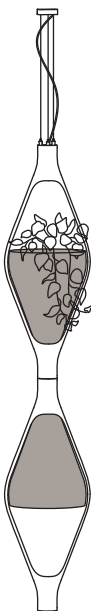
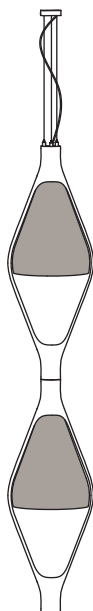

max 6 kg

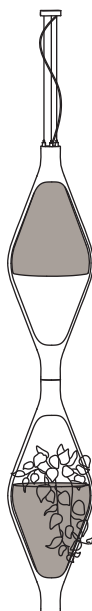

max 6 kg



max 6 kg



max 6 kg

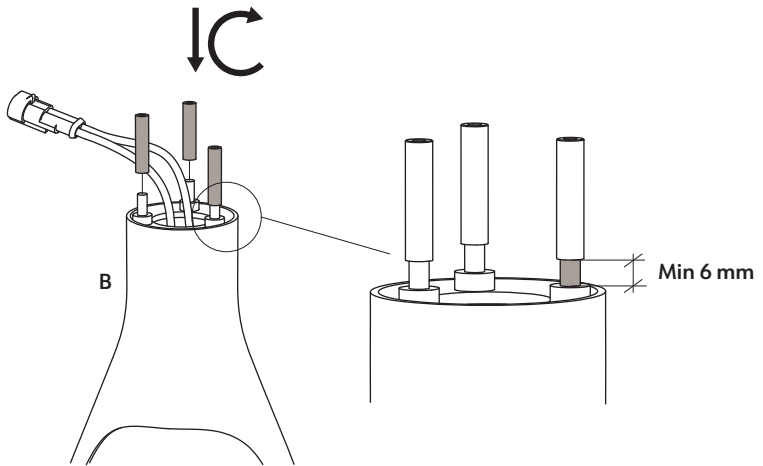
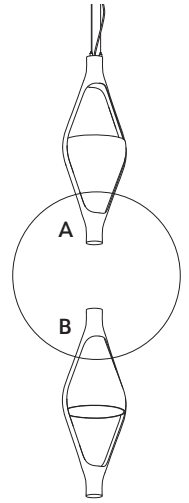
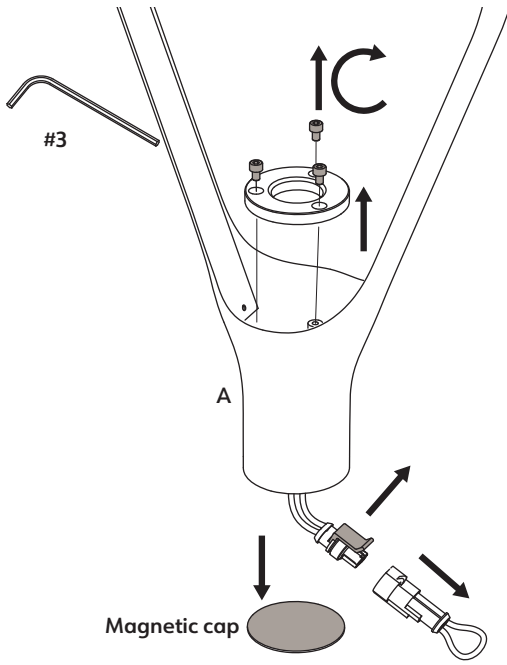

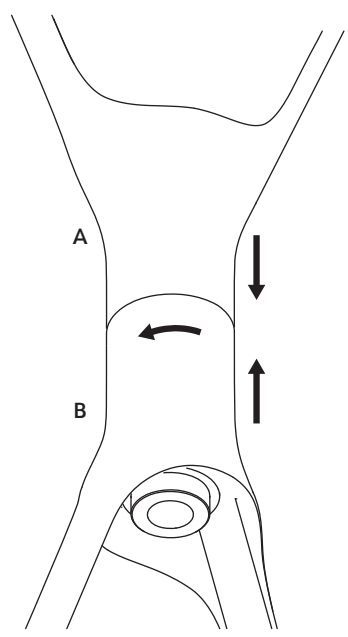
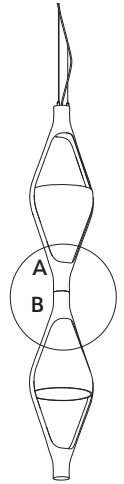
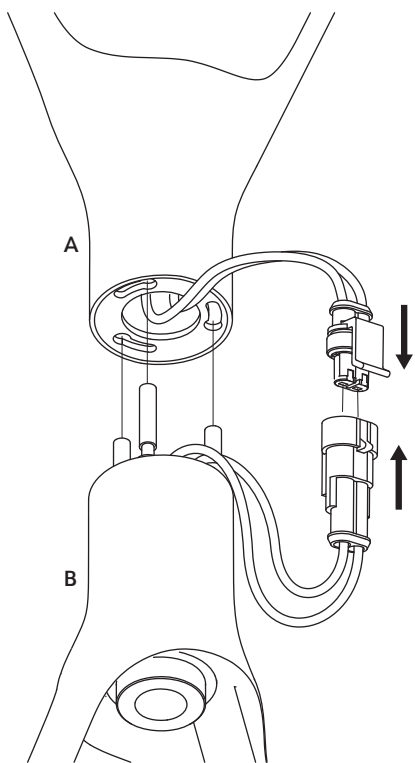

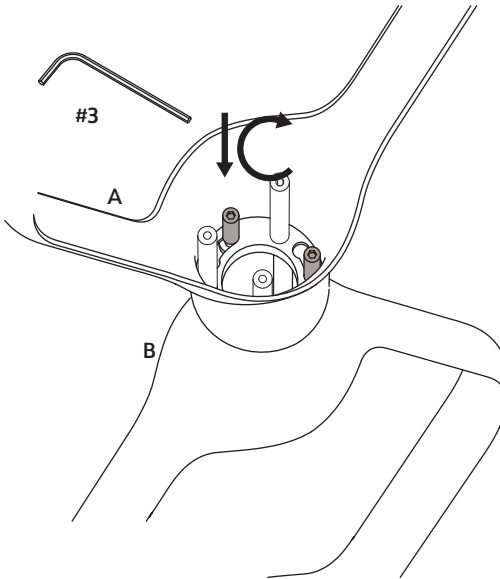
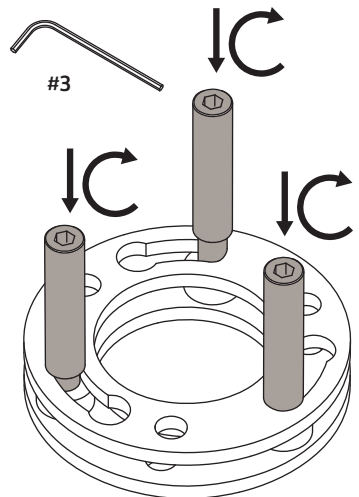
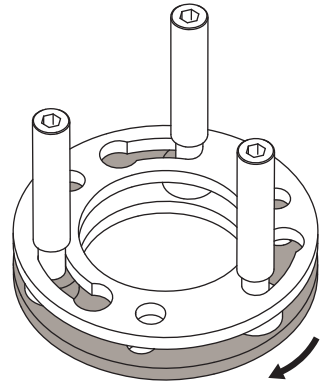
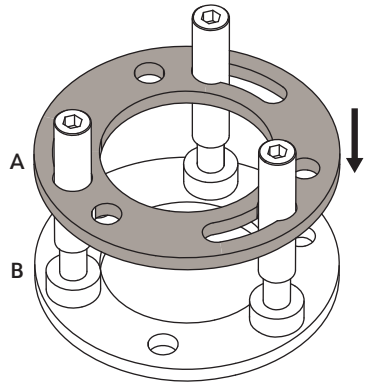

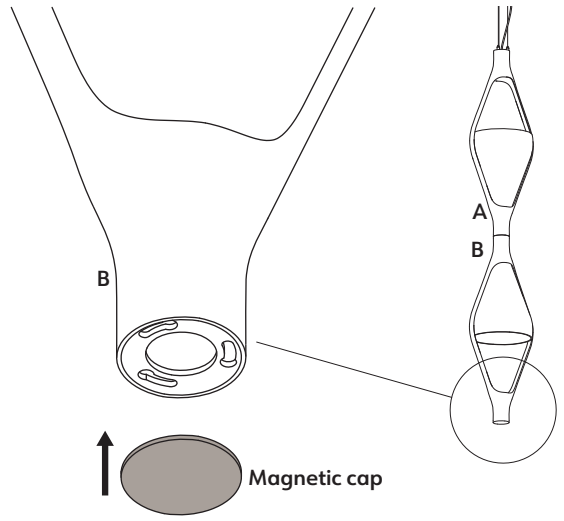
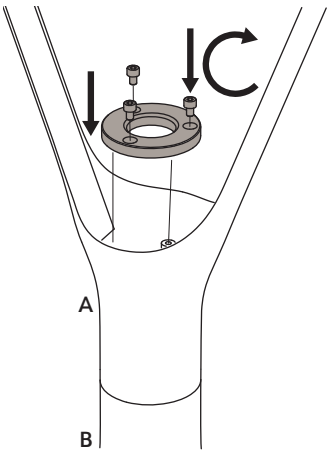

.10

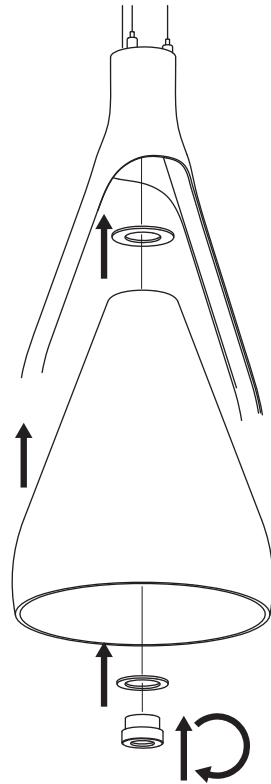
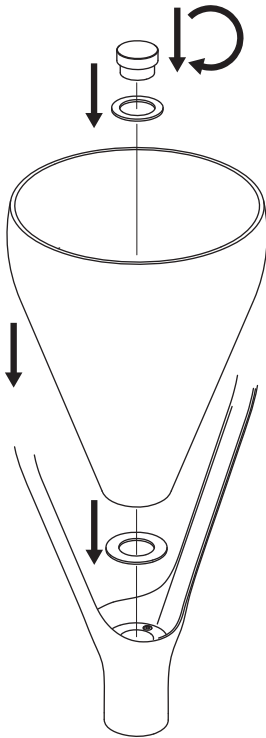

.11

BULBS, LAMPADINE, AMPOULES, LEUCHTENMITTEL, BOMBILLAS

Viceversa

board LED 1 x 6,5W - 2700K - 800lm - CRI>90

Energy efficiency class A+

Viceversa 2

board LED 2 x 6,5W - 2700K - 1600lm - CRI>90

Energy efficiency class A+

FEEDING, ALIMENTAZIONE, ALIMENTATION, SPANNUNG, TENSION DE RED

220-240 / 120 V

