

# TRIPOD ceiling

design: Christophe Pillet / 2002

# KUNDALINI

Lampada a sospensione, struttura in metallo verniciato grigio o bianco. Paralume in tessuto ignifugo chiuso da disco in metallo microforato e verniciato.

*Suspension lamp, structure in grey or white painted metal. Shade in fire-resistant fabric closed by a painted perforated metallic disc.*



## CERTIFICAZIONI - CERTIFICATIONS



Apparecchio di classe I  
Product in class I

IP20

Apparecchio per uso interno  
Product for indoor use



Apparecchio conforme alla direttiva europea 2006/95/EC  
Product in conformity with the European directive 2006/95/EC



Apparecchio conforme allo standard ETL (versioni USA e Canada)  
Product in conformity with ETL standard (USA and Canada version)



Apparecchio di illuminazione da smaltire secondo la direttiva EU 2002/96/EC  
This lamp must be disposed in conformity with the EU directive 2002/96/EC

## DIMENSIONI - DIMENSIONS

Front view

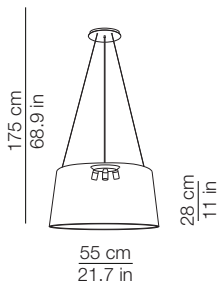

Top view

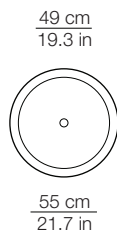

## IMBALLO - PACKAGING

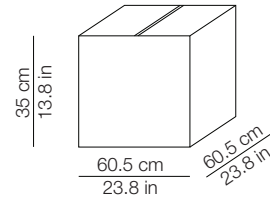

Volume: 0.128 m<sup>3</sup> / 4.524 ft<sup>3</sup>  
Gross weight: 5.3 kg / 11.7 lbs

## MATERIALI E FINITURE - MATERIALS AND FINISHINGS

paralume  
shade

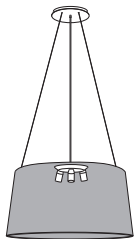

bianco - white



struttura  
structure



ecrù



moka



paralume in tessuto ignifugo  
fire resistant fabric shade

paralume  
shade



bianco - white  
RAL 9010



grigio - grey  
RAL 9006



struttura  
structure

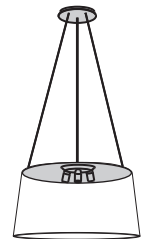

struttura in metallo verniciato  
varnished metal structure

## INFORMAZIONI AGGIUNTIVE - FURTHER INFORMATION

230V  
or  
120V

Alimentazione  
Feeding



Lampadine - Bulbs  
3 x max77W E27 (E26 US) - Halogen  
or 3 x max21W E27 (E26 US) - Fluorescent  
or 3 x 16W E27 (E26 US) - Led



Energy efficiency class from A+ to E

Lampada a sospensione  
Suspension lamp



Rosone - diam. ca. 22.5cm h. 3cm - bianco o grigio  
fissato a soffitto con tasselli (2-4) non forniti  
Canopy - diam. about 8.8cm h. 1.2cm - white or grey  
fixed to the ceiling with not provided screws (2-4)



Cavo di alimentazione trasparente - lunghezza 180cm  
+ 3 cavi di sospensione in acciaio - lunghezza ca. 180cm  
altre lunghezze su richiesta  
Transparent cord set - length 70.8cm  
+ 3 suspension steel wires - length ca. 70.8cm  
different lengths on request



# KUNDALINI



## ISTRUZIONI DI MONTAGGIO ASSEMBLY INSTRUCTIONS MONTAGE-ANLEITUNG INSTRUCTIONS DE MONTAGE INSTRUCCIONES DE MONTAJE

**TRIPOD** Christophe Pillet, 2002

KUNDALINI S.R.L.  
Viale L. Da Vinci, 277  
20090 Trezzano S/N  
(Milano) - Italy

T +39 02 365 389 50  
F +39 02 365 389 64  
info@kundalini.it  
www.kundalini.it

### ATTENZIONE

La sicurezza dell'apparecchio è garantita con l'uso appropriato delle seguenti istruzioni, pertanto è necessario conservarle.

Togliere sempre la tensione prima di operare sull'apparecchio.

Per pulire la lampada non usare mai prodotti abrasivi o detergenti aggressivi.

Se il cavo esterno di questo apparecchio viene danneggiato, deve essere sostituito esclusivamente dal costruttore, dal suo servizio assistenza, o da personale qualificato equivalente, al fine di evitare pericoli.

Kundalini non effettuerà nessuna sostituzione se non dopo aver accertato la natura del difetto.

### WARNING

The safety is guaranteed by the appropriate use of the following instructions, so you must keep them.

Always disconnect the main voltage before working on the appliance.

Never use abrasive products or aggressive detergents for cleaning the lamp.

If the external cable of this appliance is damaged, it must be replaced by the manufacturer, its after sales service or other equivalent qualified person only in order to avoid any danger.

Kundalini will not provide a replacement until the nature of defect has been determined.

### ACHTUNG

Die Sicherheit dieses Artikels wird nur durch die strikte Befolgung der nachfolgenden Betriebsanleitung gewährleistet. Bitte heben Sie diese unbedingt auf.

Vor allen Arbeiten ziehen Sie bitte den Stecker aus der Dose.

Für die Reinigung der Lampe niemals Schleifmittel oder aggressive Reinigungsmittel verwenden

Sollte das Außenkabel der Lampe beschädigt werden, ist es ausschließlich vom Service-Dienst des Herstellers oder gleichwertigen, qualifiziertem Personal auszutauschen, um somit Gefahren zu vermeiden.

Kundalini leistet grundsätzlich erst nach einer gründlichen Überprüfung Ersatz.

### ATTENTION

La sûreté de l'appareil n'est garantie qu'en suivant scrupuleusement les instructions ci-après. Il est donc nécessaire de les conserver.

Isoler l'appareil du secteur avant toute manipulation.

Pour nettoyer la lampe, ne jamais utiliser de produits abrasifs ou de nettoyeurs agressifs.

Si le câble externe de cet appareil est endommagé, il doit être remplacé uniquement par les soins du constructeur, par son service après-vente ou bien par le personnel équivalent, et ce afin d'éviter tout danger.

Kundalini ne remplacera aucun appareil sans en avoir pu vérifier le défaut.

### ATENCIÓN

La seguridad del aparato está garantizada sólo con el uso apropiado de las instrucciones siguientes, por lo tanto es necesario atenderlas puntualmente.

Desconectar siempre la alimentación antes de trabajar en el aparato.

Nunca utilice productos abrasivos o detergentes agresivos para limpiar la lámpara.

Si el cable externo de este aparato se deteriora será necesario sustituirlo; la sustitución podrá efectuarla exclusivamente el fabricante, su servicio de asistencia o personal cualificado equivalente para evitar peligros.

Kundalini no efectuará sustitución alguna hasta después de haber verificado la naturaleza del defecto.

### Lampadine-Bulbs-Leuchtmittel-Ampoules-Bombillas:

#### Tripod Table

3 x max 40W E14 (E12US) - Clear halogen  
or 3 x max 12W E14 (E12US) - Candle fluorescent  
or 3 x 13W E14 (E12US) - Led

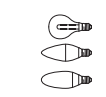

#### Tripod Floor/Tripod Ceiling

3 x max 70W E27 (E26US) - Tubular halogen  
or 3 x max 21W E27 (E26US) - Fluorescent  
or 3 x 13W E27 (E26US) - Led

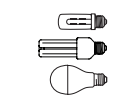

### Energy efficiency class from A+ to E

Alimentazione-Feeding-Spannung-Alimentation-Tensión de red:  
220-240V

 Classe I-Class I-Schutzklasse I-Classe I-Class I (Tripod Ceiling)

 Classe II-Class II-Schutzklasse II-Classe II-Class II (Tripod Floor / Table)

 IT-Apparecchio idoneo ad essere installato su superfici normalmente infiammabili.

EN-Appliance suitable for installation on normally inflammable surfaces.

DE-Gerät, welches auf Oberflächen installiert werden kann, die normalerweise entzündbar sind.

FR-Appareil destiné à être installé des surfaces normalement inflammables.

ES-Aparato apto para ser instalado sobre superficies normalmente inflamables.

 IT-Attesta la conformità del prodotto alle disposizioni delle direttive comunitarie.  
EN-It certifies the conformity of the product to the european community low voltage directive.

DE-Das Zeichen bestätigt die Übereinstimmung des Produkts mit den Bestimmungen der EU-Richtlinien.

FR-Il atteste la conformité du produit aux dispositions des directives communautaires.

ES-Certifica la conformidad del producto a las disposiciones de las normas de la comunidad.

 IT-Il simbolo RAEE utilizzato per questo prodotto indica che quest'ultimo non può essere trattato come rifiuto domestico.

EN-The use of the WEEE symbol indicates that this product may not be treated as household waste.

DE-Durch Verwendung des WEEE-Symbols weisen wir darauf hin, dass dieses Produkt nicht als normaler Haushaltsmüll behandelt werden darf.

FR-L'utilisation du symbole WEEE indique que ce produit ne peut pas être traité comme déchet domestique.

ES-El símbolo RAEE en un producto indica que éste no se puede eliminar como cualquier otra basura.

## TRIPOD FLOOR/TABLE

①

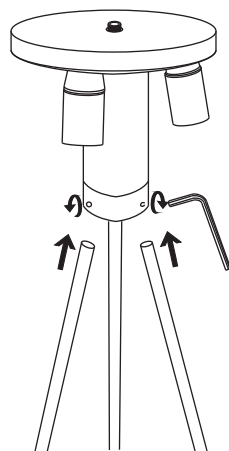

②

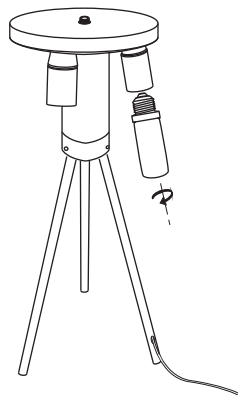

③

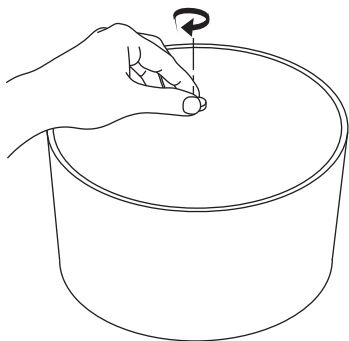

## TRIPOD CEILING

④

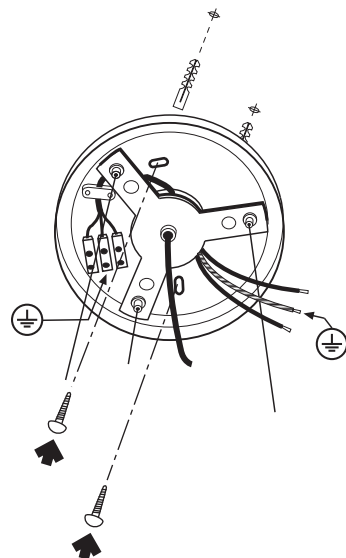

⑤

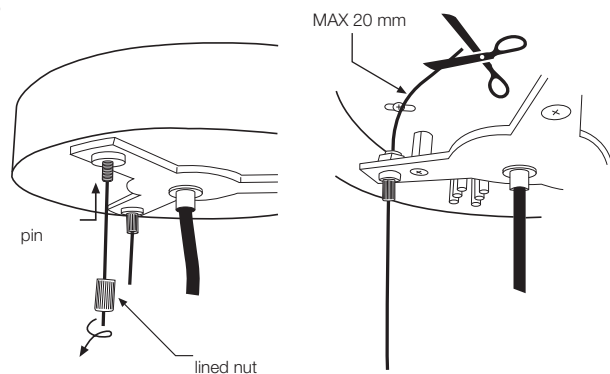

⑥

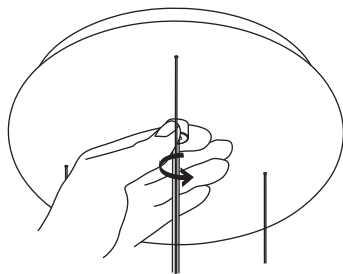

⑦

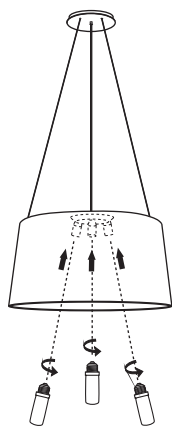

## ISTRUZIONI DI MONTAGGIO

### Tripod Floor/Table

Estrarre la struttura della lampada dall'imballo. Inserire le due barre nelle apposite sedi e procedere al serraggio delle stesse - **Fig.1** -. Avvitare le lampadine - **Fig.2** -. Inserire il diffusore sulla struttura maneggiandolo con cura. Avvitare la ghiera di chiusura - **Fig.3** -. Inserire la spina.

### Tripod Ceiling

Togliere la tensione all'impianto elettrico generale. Far passare i cavi elettrici di rete attraverso il foro centrale del rosone e fissare quest'ultimo utilizzando viti e controviti a espansione adatte alle caratteristiche del soffitto. Collegare i cavi alla morsettiera del rosone notando che quello di terra deve essere cablato alla posizione contrassegnata da  $\oplus$  - **Fig.4** -. Per regolare l'altezza svitare le ghiera dei 3 fermacavi di acciaio. Premendo i sottostanti puntali, i cavi vengono liberati rendendo possibile la regolazione. Tagliare il cavo in eccesso a una lunghezza massima di 20 mm - **Fig.5** -. Al raggiungimento dell'altezza voluta, rilasciare i blocchi in modo che questi possano fermare automaticamente i cavi. Verificare il corretto allineamento orizzontale e fissare il coprirosone agendo sull'apposita vite di serraggio - **Fig.6** -. Installare le lampadine - **Fig.7** -. Ripristinare la tensione di rete. In caso di ridimensionamento del cavo di alimentazione assicurarsi che il conduttore di messa a terra sia 30 mm più lungo degli altri conduttori.

## ASSEMBLY INSTRUCTIONS

### Tripod Floor/Table

Extract the lamp structure from its packaging. Insert and screw the legs to the structure - **Fig.1** -. Screw down the bulbs - **Fig.2** -. Insert the diffuser upon the structure handling it with care. Close the metal ring - **Fig.3** -. Insert the plug.

### Tripod Ceiling

Turn off the electricity. Pass the supply cables through the central hole of the canopy and fix it with expansion screws to the ceiling. Connect the cables to the clips making sure that the ground cable is fixed to the clip marked as  $\oplus$  - **Fig.4** -. To adjust the height of the lamp, unscrew the 3 steel wires clamps lined nuts. Press the clamp pins to free the steel wires then shift them until the right height is achieved. Cut the steel wires in excess at a maximum length of 20 mm - **Fig.5** -. Make sure that the lamp is aligned along the horizontal line and close, by hand, the cover of the canopy with the ring nut - **Fig.6** -. Install the bulbs - **Fig.7** -. Turn on electricity. In case of resizing of the power cable make sure the earth connection is 30 mm longer than the other conductors.

## MONTAGE-ANLEITUNG

### Tripod Floor/Table

Die Lampenkonstruktion aus der Verpackung nehmen. Die beiden Stangen in die entsprechenden Sitze einstecken und sie festziehen - **Abb.1** -. Die Glühbirnen festschrauben - **Abb.2** -. Den Diffusor vorsichtig in die Konstruktion einfügen. Den Verschlussring festschrauben - **Abb.3** -. Den Stecker einstecken.

### Tripod Ceiling

Die Netzspannung der elektrischen Anlage abschalten. Die elektrischen Netzkabel durch das Loch in der Mitte der Rosette führen und diese befestigen, dabei Schrauben und Spreizmutter verwenden, die für die jeweilige Decke geeignet sind. Die Kabel mit dem Klemmenbrett der Rosette verbinden, dabei darauf achten, dass das Erdungskabel mit der gekennzeichneten Position  $\oplus$  verkabelt werden muss - **Abb.4** -. Zur Regulierung der Höhe die Ringe der 3 Kabelhalter aus Stahl losschrauben. Durch Druck auf die darunter befindlichen Zwingen

werden die Kabel frei und ermöglichen eine Regulierung. Das überschüssige Kabel auf maximal 20 mm abschneiden - **Abb.5** -. Nach Erreichen der gewünschten Höhe die Kabelstopper loslassen, damit diese automatisch die Kabel arretieren können. Sicherstellen, dass waagrecht alles eine Reihe bildet und über die entsprechende Feststellschraube die Abdeckung der Rosette befestigen - **Abb.6** -. Die Glühbirnen einsetzen - **Abb.7** -. Die Netzspannung wiederherstellen. Bei Verkürzung des Versorgungskabels sicherstellen, dass der Erdleiter 30 mm länger als die anderen Leiter ist.

## INSTRUCTIONS DE MONTAGE

### Trépied Sol/Table

Extraire la structure de la lampe de l'emballage. Insérer les deux barres dans les emplacements prévus et effectuer le serrage de ces dernières - **Fig.1** -. Visser les ampoules - **Fig.2** -. Insérer le diffuseur sur la structure en manipulant avec soin. Visser le manchon de fermeture - **Fig.3** -. Insérer la prise.

### Trépied Plafond

Couper le courant du système électrique général. Faire passer les fils électriques à travers le trou central de la rosace et fixer cette dernière en utilisant des vis et chevilles à expansion adaptées aux caractéristiques du plafond. Raccorder les fils aux bornes de la rosace en faisant attention à ce que celui de terre soit raccordé à la position indiquée par  $\oplus$  - **Fig.4** -. Pour régler la hauteur, dévisser les manchons des 3 bloque-câble en acier. En appuyant sur les pointes en dessous, on libère les câbles, ce qui permet le réglage. Couper le câble en excès à une longueur maximale de 20 mm - **Fig.5** -. A l'obtention de la hauteur souhaitée, relâcher les blocs de façon à ce que ces derniers puissent arrêter automatiquement les câbles. Vérifier l'alignement horizontal correct et fixer le couvre-rosace en agissant sur la vis de serrage prévue - **Fig.6** -. Mettre en place les ampoules - **Fig.7** -. Rebrancher le courant. En cas de redimensionnement du câble d'alimentation, s'assurer que le conducteur de mise à la terre soit 30 mm plus long que les autres conducteurs.

## INSTRUCCIONES DE MONTAJE

### Tripod Floor/Table

Sacar la estructura de la lámpara del embalaje. Insertar las dos barras en sus correspondientes ubicaciones y proceder a ajustarlas - **Fig.1** -. Insertar las bombillas - **Fig.2** -. Insertar el difusor en la estructura manejándola con cuidado. Enroscar la abrazadera de cierre - **Fig.3** -. Conectar el enchufe.

### Tripod Ceiling

Quitarle la tensión a la instalación eléctrica general. Meter los cables eléctricos de red a través del correspondiente agujero del plafón y fijar este último utilizando tornillos y tacos de expansión apropiados para las características del techo. Conectar los cables a la bornera del plafón advirtiéndole que el cable de tierra se debe enchufar en la posición señalada por  $\oplus$  - **Fig.4** -. Para regular la altura desenroscar las 3 abrazaderas de los cables de acero. Presionando los puntales subyacentes, los cables se sueltan haciendo posible la regulación. Cortar el cable en exceso a una longitud máxima de 20 mm - **Fig.5** -. Cuando se alcance la altura deseada, soltar los bloques para que estos puedan detener automáticamente los cables. Comprobar la correcta alineación horizontal y fijar la tapa del plafón con el correspondiente tornillo de fijación - **Fig.6** -. Instalar las bombillas - **Fig.7** -. Restablecer la tensión de red. En caso de cambiar el cable de alimentación, asegurarse de que el conductor de puesta a tierra sea 30 mm más largo que los otros conductores.