

Alexander

ARMCHAIR & OTTOMAN

Alexander is a highly innovative solution linked to a functional and quite traditional shape. A powerful and embracing structure where a high back smoothly connects to the seat cushion and ends on a swivel base. The arms and backrest on this piece slightly arch outwards, inviting everyone to sit. The highlight goes to the additional support padding in the back, held up by a metallic opulent counterweight, that can be adjusted in height and produced in a different finish. This timeless armchair coordinates perfectly its materials in a one-of-a-kind piece, especially when presented in a cross-stitched seam.



Specifications

Dimensions (Armchair)

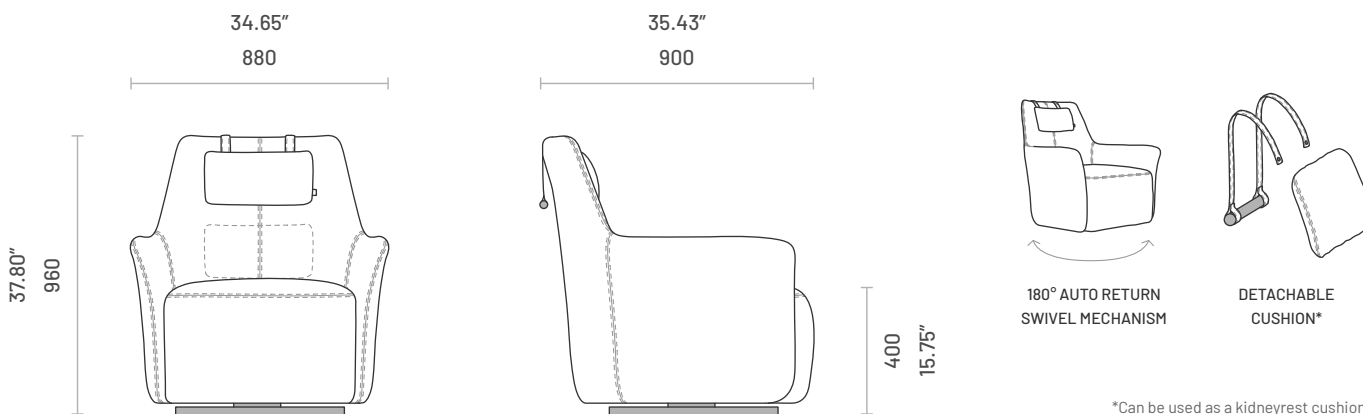

Dimensions (Ottoman)

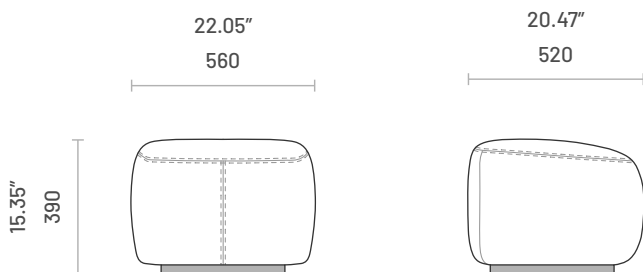

Technical Information

Frame

Solid pine wood, plywood and MDF

Padding

Seat: 30kg/m³, 23kg/m³, 55kg/m³ polyurethane foam and 100gr polyester fiber
 Backrest: 30kg/m³, 23kg/m³ polyurethane foam and 100gr polyester fiber
 Armrests: 30kg/m³ polyurethane foam and 100gr polyester fiber
 Ottoman: 23kg/m³, 30kg/m³, 55kg/m³ polyurethane foam and 200gr polyester fiber
 Cushion: Mixed polyester staple fiber and feathers

Materials and Finishes



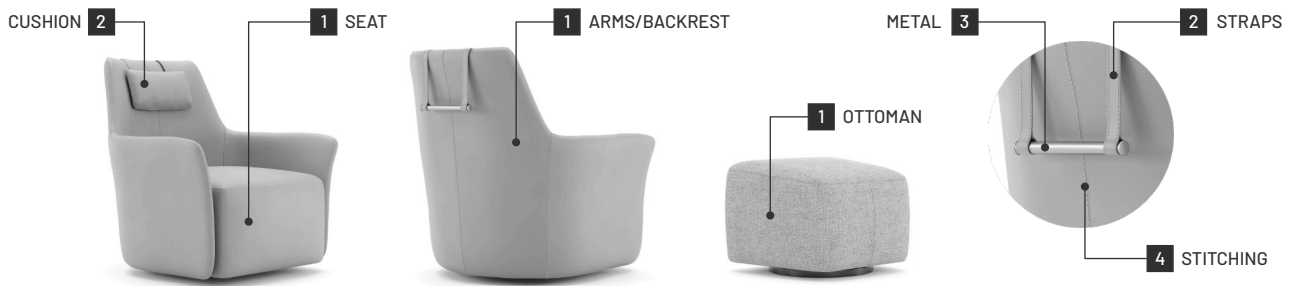

Overview



Available Finishes

	1	2	3	4
Fabrics				
Aldan	●	●	–	–
Arno	●	●	–	–
Astoria	●	●	–	–
Avalon	●	●	–	–
Bergen	●	●	–	–
Brampton	●	●	–	–
Clarence	●	●	–	–
Columbia	●	●	–	–
Devon	●	●	–	–
Galway	●	●	–	–
Helmand	●	●	–	–
Hudson	●	●	–	–
Osaka	●	●	–	–
Provence	●	●	–	–
Synthetic Leathers				
Rupert	●	●	–	–
Natural Leathers				
Albany	–	–	–	–
Aspen	●	●	–	–
Dover	●	●	–	–
Metals				
White Texturized	–	–	●	–
Black Texturized	–	–	●	–
Silver Polished	–	–	●	–
Gold Polished	–	–	●	–
Gold Brushed	–	–	●	–
Rose Gold Matte	–	–	●	–
Onyx Polished	–	–	●	–
Smoky Black Polished	–	–	●	–
Stitches				
Double Top Stitch	–	–	–	●
Cross Stitch	–	–	–	●
Blanket Stitch	–	–	–	–
Zigzag Stitch	–	–	–	–

COM Fabric and Leather Requirements

Item	1		2	
	Fabric 	Leather 	Fabric 	Leather 
Alexander Armchair	3.60 lm 11.81 ft	7.20 m2 77.76 ft2	0.70 lm 2.30 ft	1.40 m2 15.12 ft2
Alexander Ottoman	2.50 lm 8.20 ft	5.00 m2 54.00 ft2	—	—

Packaging Information

Item	Number of Packages	Packaging Dimensions	Packaging Weight	
Armchair	1	Width: 950mm (37.40") Depth: 950mm (37.40") Height: 1070mm (42.13") Volume: 0.97m ³ (34.10ft ³)	46.00kg	101.41lb
Ottoman	1	Width: 600mm (23.62") Depth: 600mm (23.62") Height: 470mm (18.50") Volume: 0.169m ³ (5.97ft ³)	17.00kg	37.47lb