



SWITCH 306

Nendo
2007

Lampada da terra luce diretta e indiretta. Riflettore e struttura in metallo. Accensione on/off mediante la rotazione del riflettore.

Floor lamp giving direct and indirect light. Metal structure and reflector. On/off lighting by reflector's rotation.

DIMENSIONI/DIMENSIONS

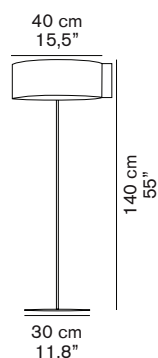

MATERIALI/MATERIALS

metallo
metal

COLORE/COLORS

esterno nero /external black

RAL9005

esterno oro satinato/external satin gold

SORGENTI/BULBS

2 x max 100 W - E27

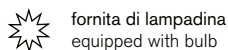

fornita di lampadina
equipped with bulb

MARCHI/MARKS



INFORMAZIONI AGGIUNTIVE/ FURTHER INFORMATION



classe I
class I



cavo nero
black cable



interruttore
on/off switch



classe energetica: A⁺, A, B, C, D
energy class: A⁺, A, B, C, D

IMBALLO/PACKAGING



Riflettore/Reflector

dim./dim. 46x46x28 cm / 18,1"x18,1"x11"
volume/volume 0,0592 m³ / 2,09 ft³
peso/weight 4,3 kg / 9,47 lb



Base/Base

dim./dim. 36x42x147 cm / 14,2"x16,5"x57,9"
volume/volume 0,222 m³ / 7,84 ft³
peso/weight 9,7 kg / 21,38 lb

TIPOLOGIA/TYPE

interno - lampada da terra
indoor - floor lamp

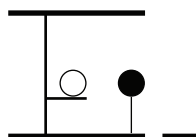

CURVA FOTOMETRICA/ PHOTOMETRIC CURVE

Switch Floor Lamp

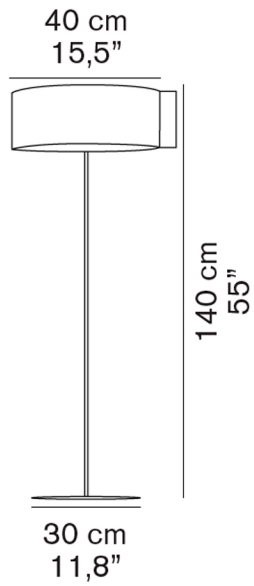

SWITCH

206 - 306

designer Nendo

oluce

ISTRUZIONI PER IL MONTAGGIO MOUNTING INSTRUCTIONS INSTRUCTION POUR LE MONTAGE MONTAGEANLEITUNG

O luce S.r.l.

Via Brescia, 2 - 20097 San Donato Milanese (Mi) - Italia
Tel. +39 2 9849 1435 - Fax +39 2 9849 0779
http://www.oluce.com - e-mail : info@oluce.com

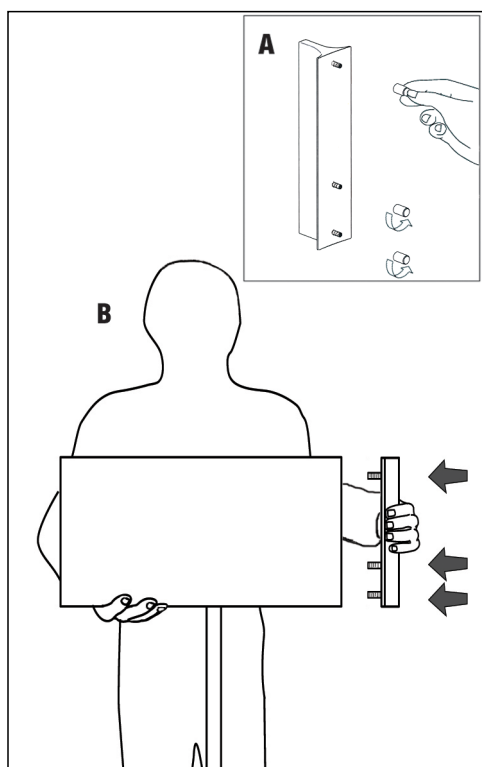

fig. 1

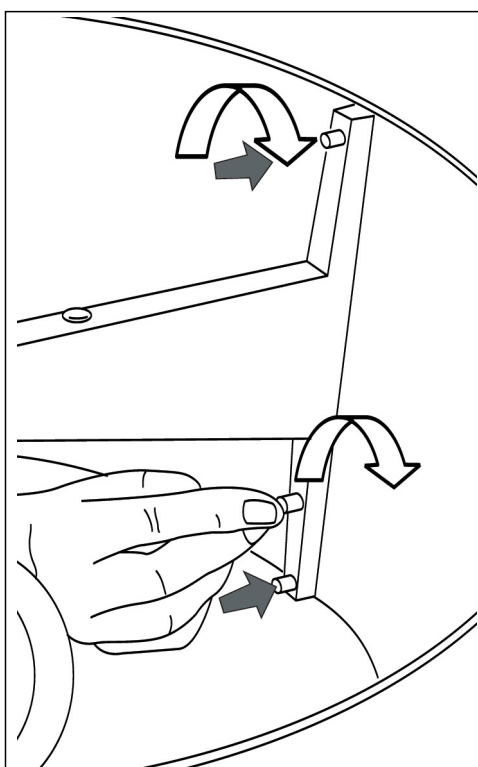

fig. 2

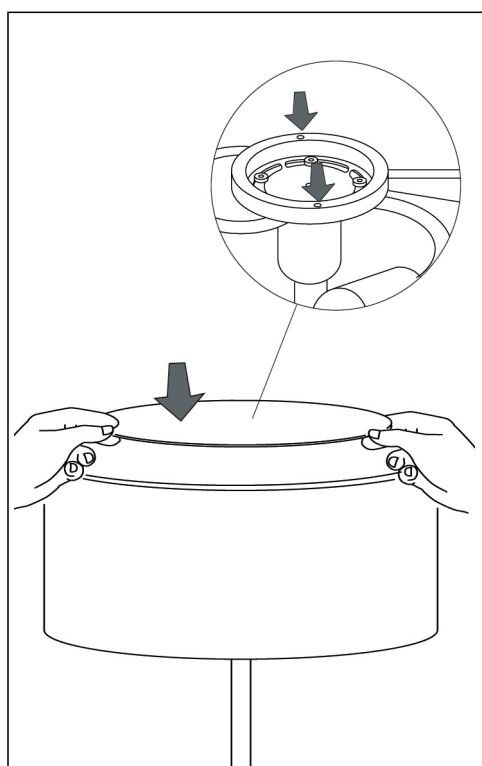

fig. 3

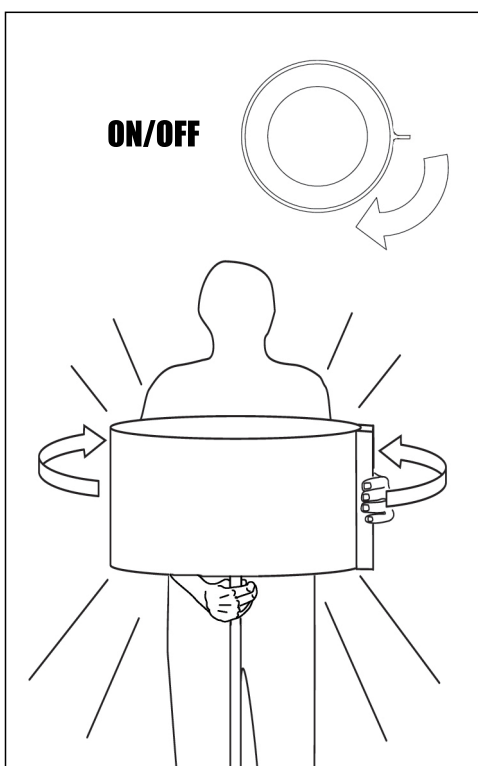

fig. 4

206 - 2 x max 100W(E27) ↑ 55 Ø 40 cm

306 - 2 x max 100W(E27) ↑ 140 Ø 40 cm

IT - Per la sicurezza elettrica ed il corretto montaggio della lampada seguire la sequenza delle immagini.

Disinserire la rete di alimentazione prima di intervenire sulla lampada. Per pulire la lampada non usare detersivi abrasivi.

EN - For electrical safety and a correct lamp assembly, follow the sequence of the pictures. **Cut off the electrical current before any intervention on the lamp.** Do not use abrasive detergents when cleaning the lamp.

FR - Pour la sécurité électrique et un montage correct de la lampe, suivre la séquence des images. **Débrancher le courant électrique avant d'intervenir sur la lampe.** Ne pas employer de détergents abrasifs pour nettoyer la lampe.

DE - Zwecks der elektrischen Sicherheit und zur korrekten Montage, die Reihenfolge der Abbildungen verfolgen. **Vor Handhabung der Lampe, elektrischen Strom ausschalten.** Keine ätzenden Reinigungsmittel zum Säubern der Lampe verwenden.



CLASSE I - CLASS I - CLASSE I - KLASSE I
Terra • Ground • Terre • Sicherheitserdung

IT - COLLEGAMENTO DEL CAVO DI TIPO Y: in caso di danneggiamento del cavo di alimentazione, questo deve essere sostituito dall'assistenza o dal personale qualificato.

EN - CONNECTION OF CABLE TYPE Y: in case of power cable damage it has to be replaced by customer service or by the qualified personnel.

FR - CONNEXION DU CÂBLE TYPE (RÉF) Y: en cas de dommage du câble électrique le câble doit être remplacé par le service clientèle ou par du personnel qualifié.

DE - KABELANSCHLUSS TYP Y: Bei Beschädigung des Speisekabels muss dieses vom Kundendienst oder vom Fachpersonal ausgewechselt werden.



IT - Il simbolo indica l'idoneità degli apparecchi al montaggio diretto su superfici normalmente infiammabili.

EN - The symbol indicates the suitability of fixtures to be mounted directly on normally inflammable surfaces.

FR - Le symbole indique que les appareils sont indiqués pour être montés directement sur des surfaces normalement inflammables.

DE - Das Symbol zeigt an, ob die Geräte dazu geeignet sind, auf normal entflammaren Oberflächen angebracht zu werden.



IT - Questo prodotto non deve essere smaltito come un rifiuto municipale misto, effettuare una raccolta separata.

EN - This product must not be discarded as the responsibility of the City sanitation, it must be gathered together separately and discarded.

FR - Ce produit ne doit pas être mis avec les ordures municipales, il faut effectuer un ramassage séparé.

DE - Dieses Produkt darf nicht als Gemeindekehricht entsorgt werden. Entsorgung muss getrennt erfolgen.