



COUPÈ 1159/R

Joe Colombo
1967

Lampada da parete orientabile e regolabile in metallo a luce diretta e riflessa.

Adjustable rotating metal wall lamp giving direct and reflected light.

DIMENSIONI/DIMENSIONS

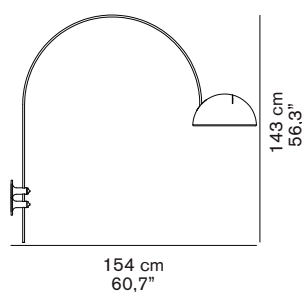

MATERIALI/MATERIALS

metallo/alluminio
metal/aluminium

COLORE/COLORS

bianco lucido/lacquered white RAL9003
nero lucido/lacquered black RAL9005

SORGENTI/BULBS

1 x max 100 W - E27



fornita senza lampadina
equipped without bulb

Nota: è possibile utilizzare lampadine LED disponibili sul mercato senza alcun cambiamento o modifica relativamente al prodotto standard.

Note: lamp compatible with LED bulbs (according to the market availability and without changes to the standard product)

MARCHI/MARKS



INFORMAZIONI AGGIUNTIVE/ FURTHER INFORMATION



classe I
class I



cavo nero
black cable



classe energetica: A*, A, B, C, D
energy class: A*, A, B, C, D

IMBALLO/PACKAGING



Arco/Arc

dim./dim. 100x165x5 cm / 39,4"x65"x2"
volume/volume 0,0825 m³ / 2,91 ft³
peso/weight 5,1 kg / 11,24 lb



Riflettore/Reflector

dim./dim. 43x43x29 cm / 16,9"x16,9"x11,4"
volume/volume 0,0536 m³ / 1,89 ft³
peso/weight 4,5 kg / 9,92 lb

TIPOLOGIA/TYPE

interno - lampada da parete
indoor - wall lamp

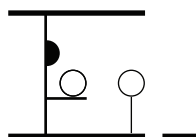

CURVA FOTOMETRICA/ PHOTOMETRIC CURVE

Coupe Wall Arch

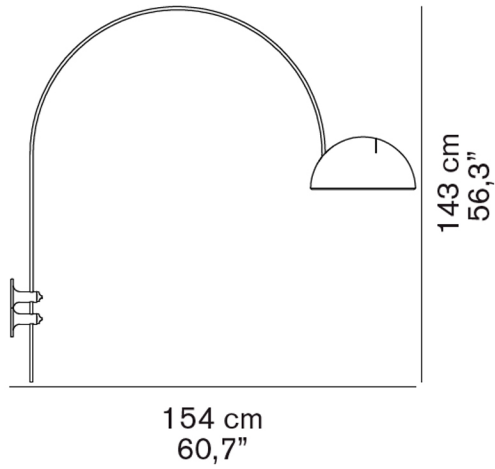

COUPÈ

1159/R

designer Joe Colombo

ISTRUZIONI PER IL MONTAGGIO MOUNTING INSTRUCTIONS INSTRUCTION POUR LE MONTAGE MONTAGEANLEITUNG

oluce

O luce S.r.l.

Via Brescia, 2 - 20097 San Donato Milanese (Mi) - Italia
Tel. +39 2 9849 1435 - Fax +39 2 9849 0779
<http://www.oluce.com> - e-mail : info@oluce.com

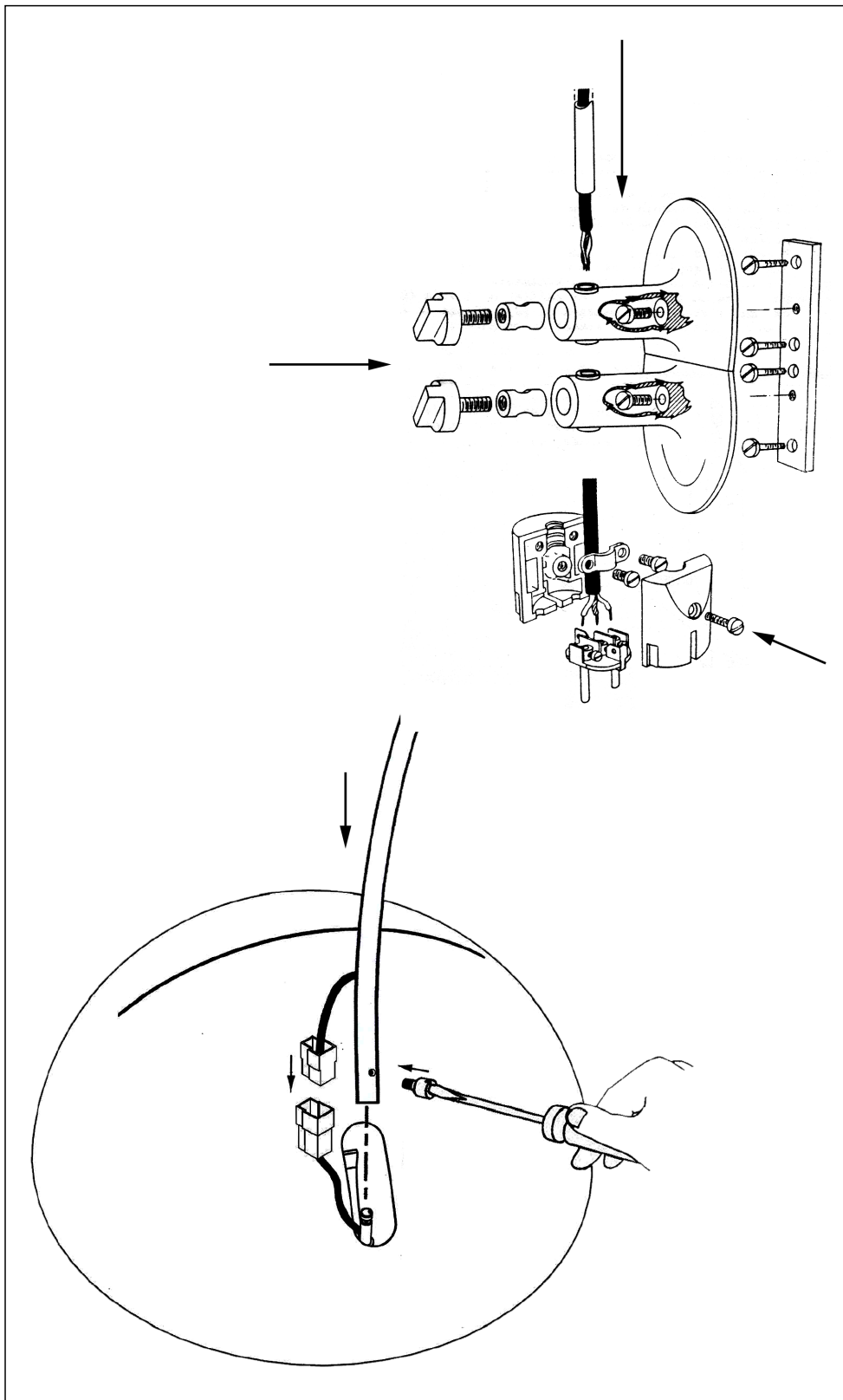

fig. 1

1159/R - 1 x max 100W(E27) ↑ 143 ↔ 154 cm

IT - Per la sicurezza elettrica ed il corretto montaggio della lampada seguire la sequenza delle immagini.

Disinserire la rete di alimentazione prima di intervenire sulla lampada. Per pulire la lampada non usare detergenti abrasivi.

EN - For electrical safety and a correct lamp assembly, follow the sequence of the pictures. **Cut off the electrical current before any intervention on the lamp.** Do not use abrasive detergents when cleaning the lamp.

FR - Pour la sécurité électrique et un montage correct de la lampe, suivre la séquence des images. **Débrancher le courant électrique avant d'intervenir sur la lampe.** Ne pas employer de détergents abrasifs pour nettoyer la lampe.

DE - Zwecks der elektrischen Sicherheit und zur korrekten Montage, die Reihenfolge der Abbildungen verfolgen. **Vor Handhabung der Lampe, elektrischen Strom ausschalten.** Keine ätzenden Reinigungsmittel zum Säubern der Lampe verwenden.

 **CLASSE I - CLASS I - CLASSE I - KLASSE I**
Terra • Ground • Terre • Sicherheitserdnh

 **IT** - Il simbolo indica l'idoneità degli apparecchi al montaggio diretto su superfici normalmente infiammabili.

EN - The symbol indicates the suitability of fixtures to be mounted directly on normally inflammable surfaces.

FR - Le symbole indique que les appareils sont indiqués pour être monté directement sur des surfaces normalement inflammables.

DE - Das Symbol zeigt an, ob die Geräte dazu geeignet sind, auf normal entflammaren Oberflächen angebracht zu werden.

 **IT** - Questo prodotto non deve essere smaltito come un rifiuto municipale misto, effettuare una raccolta separata.

EN - This product must not be discarded as the responsibility of the City sanitation, it must be gathered together separately and discarded.

FR - Ce produit ne doit pas être mis avec les ordures municipales, il faut effectuer un ramassage séparé.

DE - Dieses Produkt darf nicht als Gemeindekehricht entsorgt werden. Entsorgung muss getrennt erfolgen.